

Henan E-Grind Abrasives Co. Ltd

E-Grind supplies all types PCBN Inserts for AUTO Engine Machining Industry, Aerospace Industry, Moto-cycle Industry etc.

In order to keep consistent and premium quality level, we have imported more than 60 machines from EWAG, Wendt, DMG, Coborn...

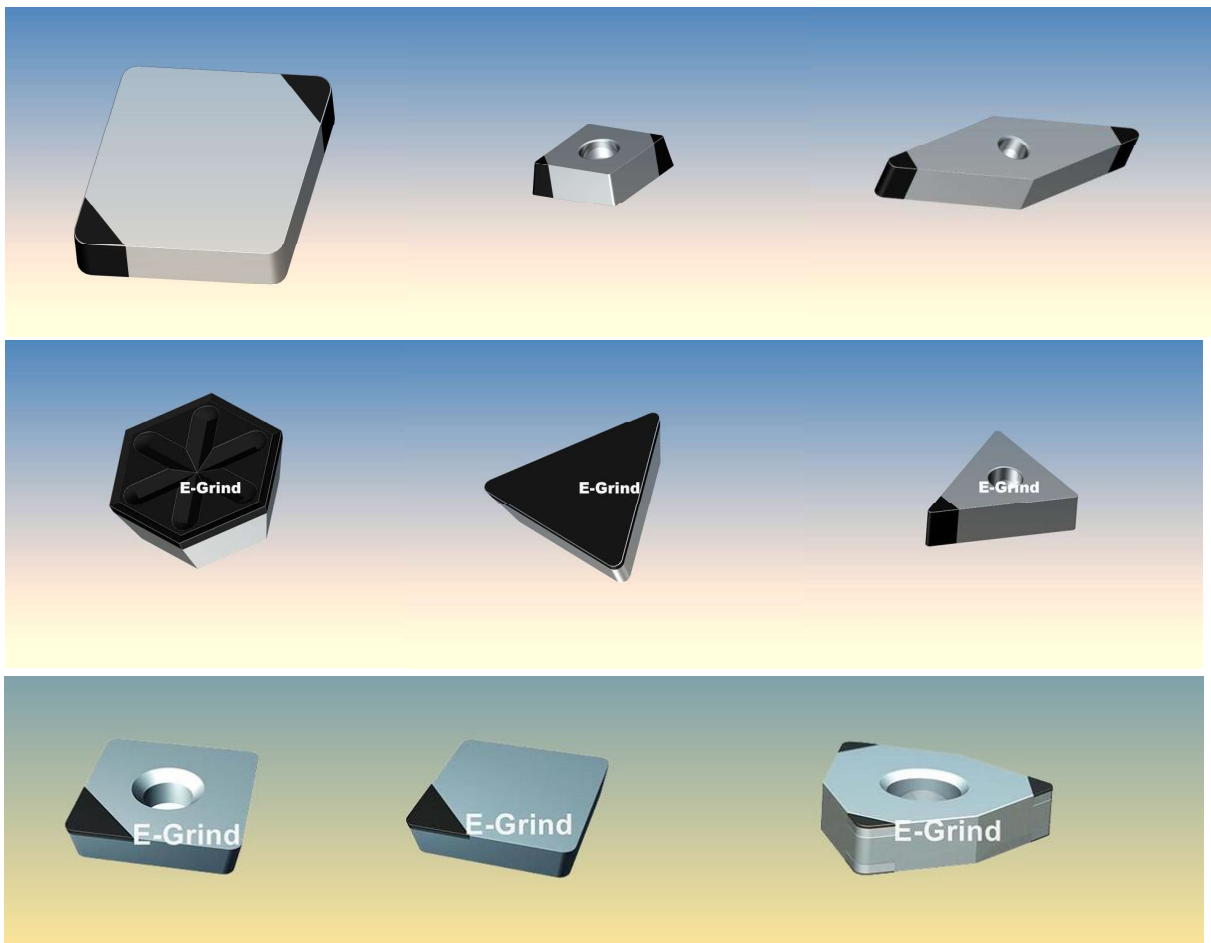

We have got ISO 9001:2000 Certified. At present our PCBN Inserts products are exported to more than 20 counties in the world such as Europe, North America, South America, Africa and Asia etc.



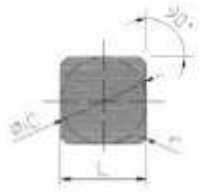

E-Grind Tool Brand Table

Grade	Characteristic	Hardness HV(Mpa)	Bending strength(Mpa)
A3N50	Fit for low speed heavy load rough machining ●High pyroconductivity,definite impact resistance. ●Fit for rough machining of high-hardness alloy cast iron, gray cast iron, nodular cast iron and other materials.	3000--3200	1100--1300
A3N60	Fit for low speed heavy load rough machining ●High pyroconductivity,definite wear resistance. ●Fit for rough machining of high-hardness alloy cast iron, gray cast iron, nodular cast iron and other materials.	3100--3300	1100--1200
A7N00	Consider abrasion resistance and tipping resistance, high-speed continuous cutting ●Fit for rough machining and semifinishing of high-hardness alloy cast iron, high nickel chromium, high ferrochrome and other materials. ●Fit for rough machining and semifinishing of gray cast iron and nodular cast iron.	3200--3400	1100--1300
A7N50	Excellent wear resistance and heat resistance, high-speed continuous cutting and milling ●Fit for semifinishing and finish machining of alloy cast iron, high nickel chromium, high ferrochrome and other materials. ●Fit for semifinishing and finish machining of gray cast iron, nodular cast iron, and other materials.	3300--3500	1100--1200
A7N60	Excellent wear resistance and heat resistance, superspeed continuous cutting and milling ●Fit for finish machining and superfinishing of alloy cast iron, high nickel chromium, high ferrochrome and other materials. ●Fit for finish machining and superfinishing of gray cast iron, nodular cast iron, etc.	3300--3400	1100--1200
A9N00	Excellent wear resistance, tipping resistance and generality, low-speed interrupted cutting ●Fit for rough machining of quenching workpieces, such as bearing steel, die steel, gauge steel, tool steel, high-speed steel and other materials.	3000--3200	1100--1300
A9N50	Excellent wear resistance and heat resistance, high-speed continuous cutting and milling ●Fit for semifinishing and finish machining of quenching workpieces, such as bearing steel, die steel, gauge steel, tool steel, high-speed steel and other materials.	3000--3200	1100--1200
A9N60	Excellent wear resistance and heat resistance, superspeed continuous cutting and milling ●Fit for semifinishing and finish machining of quenching workpieces, such as bearing steel, die steel, gauge steel, tool steel, high-speed steel and other materials.	3000--3200	1100--1300



Solid PCBN inserts

Type	Dimensions				PCBN						
ISO	L	ϕ i.c	s	r	A3N50	A7N00	A7N50	A7N60	A9N00	A9N50	A9N60
SNMN 120408	12.7	12.7	4.76	0.8	●	●	●		●	●	
SNMN 12T612	12.7	12.7	6.8	1.2	●	●	●		●	●	
SNMN 150720	15.875	15.875	7.94	2.0	●	●	●		●	●	
SNMN 201020	20.0	20.0	10.0	2.0	●	●	●		●	●	

Type	Dimensions				PCBN						
ISO	L	ϕ i.c	s	r	A3N50	A7N00	A7N50	A7N60	A9N00	A9N50	A9N60
RCMN 12T600	12.7	12.7	6.8	0	●	●	●		●	●	
RCMN 150700	15.875	15.875	7.94	0	●	●	●		●	●	
RCMN 190700	19.05	19.05	7.94	0	●	●	●		●	●	

Type	Dimensions				PCBN						
ISO	L	ϕ i.c	s	r	A3N50	A7N00	A7N50	A7N60	A9N00	A9N50	A9N60
RCMX 090700	9.525	9.525	7.94	1.0	●	●	●		●	●	
RCMX 120700	12.7	12.7	7.94	2.0	●	●	●		●	●	
RCMX 151000	15.875	15.875	10.0	2.0	●	●	●		●	●	
RCMX 191000	19.05	19.05	10.0	2.0	●	●	●		●	●	
RCMX 201200	20.0	20.0	12.0	2.0	●	●	●		●	●	
RCMX 251200	25.4	25.4	12.0	2.0	●	●	●		●	●	

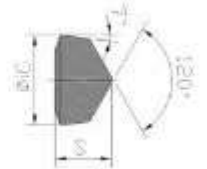

Type	Dimensions				PCBN						
ISO	L	φ i.c	s	r	A3N50	A7N00	A7N50	A7N60	A9N00	A9N50	A9N60
CNMN 120404	12.9	12.7	4.76	0.4	●	●	●		●	●	
CNMN 12T608	12.9	12.7	6.8	0.8	●	●	●		●	●	
RCMN 120712	12.9	12.7	7.94	1.2	●	●	●		●	●	

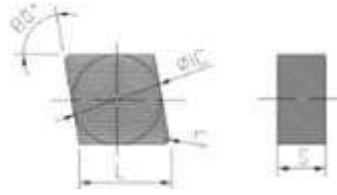

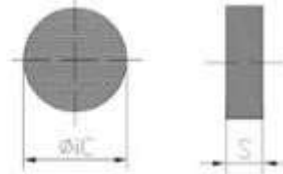
Type	Dimensions				PCBN						
ISO	L	φ i.c	s	r	A3N50	A7N00	A7N50	A7N60	A9N00	A9N50	A9N60
RNMN 251000	25.4	25.4	10.0	0	●	●	●		●	●	
RNMN 201000	20.0	20.0	10.0	0	●	●	●		●	●	
RNMN 200700	20.0	20.0	7.94	0	●	●	●		●	●	
RNMN 150700	15.875	15.875	7.94	0	●	●	●		●	●	
RNMN 12T600	12.7	12.7	6.80	0	●	●	●		●	●	
RNMN 120400	12.7	12.7	4.76	0	●	●	●		●	●	
RNMN 090400	9.525	9.525	4.76	0	●	●	●		●	●	
RNMN 080400	8.5	8.5	4.76	0	●	●	●		●	●	



Type	Dimensions				PCBN						
ISO	L	φ i.c	s	r	A3N50	A7N00	A7N50	A7N60	A9N00	A9N50	A9N60
WNMN 060304T02020	6.5	9.525	3.18	0.4	●	●	●		●	●	
WNMN 080408T02020	8.72	12.7	4.76	0.8	●	●	●		●	●	
WNMN 080412T02020	8.72	12.7	4.76	1.2	●	●	●		●	●	

● Indicate Priority Selection

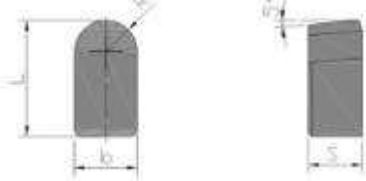
Type	Dimensions				PCBN						
ISO	R	b	L	S	A3N50	A7N00	A7N50	A7N60	A9N00	A9N50	A9N60
STB10K1	4.6	9.2	17.0	8.0	●	●	●		●	●	
BL 12K1-B	5.55	11.1	17.0	8.0	●	●	●		●	●	
BL 14K1-B	6.5	13.0	17.0	8.0	●	●	●		●	●	

Type	Dimensions				PCBN						
ISO	L	ϕ i.c	s	r	A3N50	A7N00	A7N50	A7N60	A9N00	A9N50	A9N60
RCMX090700Y	9.525	9.525	7.94	1.0	●	●	●		●	●	
RCMX120700Y	12.7	12.7	7.94	1.2	●	●	●		●	●	
RCMX150700Y	15.875	15.875	10.0	1.2	●	●	●		●	●	
RCMX190700Y	19.05	19.05	10.0	1.5	●	●	●		●	●	
RCMX200700Y	20.0	20.0	10.0	1.5	●	●	●		●	●	

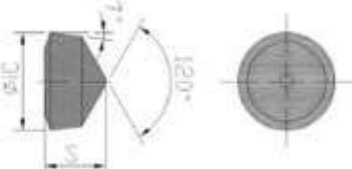

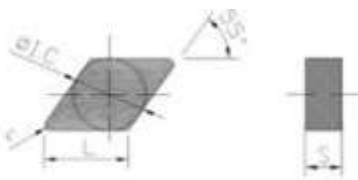

Type	Dimensions				PCBN						
ISO	L	ϕ i.c	s	r	A3N50	A7N00	A7N50	A7N60	A9N00	A9N50	A9N60
DNUN110404	11.0	9.525	4.76	0.4	●	●	●		●	●	
DNUN11T608	11.0	9.525	6.8	0.8	●	●	●		●	●	

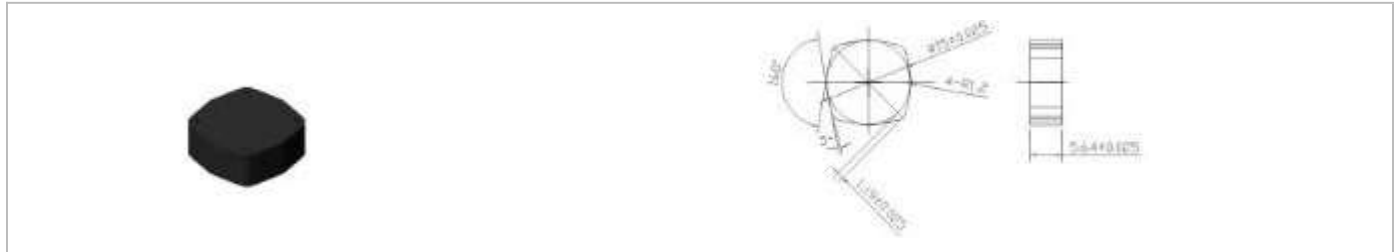

Type	Dimensions				PCBN						
------	------------	--	--	--	------	--	--	--	--	--	--

	ϕ i.c	s	ENS	A7N00	A7N50	A9N00	A9N50
SNEN1204EDE	12.7	4.76		●	●	●	●



Type	Dimensions			PCBN			
	ϕ i.c	s		A7N00	A7N50	A9N00	A9N50
KNK20W	15	5.64		●	●	●	●



Type	Dimensions			PCBN			
	ϕ i.c	s		A7N00	A7N50	A9N00	A9N50
OPHN0504ZZH-A75	12.7	4.76		●	●	●	●



Type	Dimensions			PCBN			
	ϕ i.c	s		A7N00	A7N50	A9N00	A9N50
SCGN09040822T	9.525	4.76		●	●	●	●

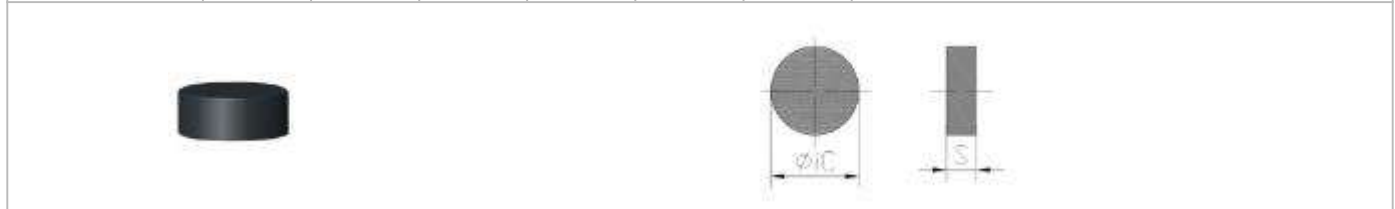

Type	Dimensions				PCBN						
ISO	L	ϕ i.c	s	r	A3N50	A7N00	A7N50	A7N60	A9N00	A9N50	A9N60
RNEN090300	9.525	9.525	3.18	0	●	●	●		●	●	
RNEN090400	9.525	9.525	4.76	0	●	●	●		●	●	

RNEN120700	12.76	12.76	7.94	0	●	●	●		●	●	
------------	-------	-------	------	---	---	---	---	--	---	---	--

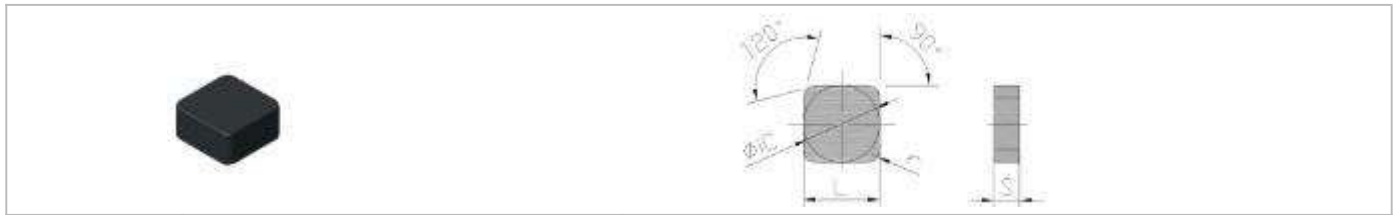

Type	Dimensions				PCBN						
ISO	L	ϕ i.c	s	r	A3N50	A7N00	A7N50	A7N60	A9N00	A9N50	A9N60
SNEN0903ENS	9.525	9.525	3.18	0.8	●	●	●		●	●	
SNEN0904ENS	9.525	9.525	4.76	0.8	●	●	●		●	●	
SNEN1207ENS	12.7	12.7	7.94	1.2	●	●	●		●	●	
SNEN0904XGR	9.525	9.525	4.76	0.8	●	●	●		●	●	

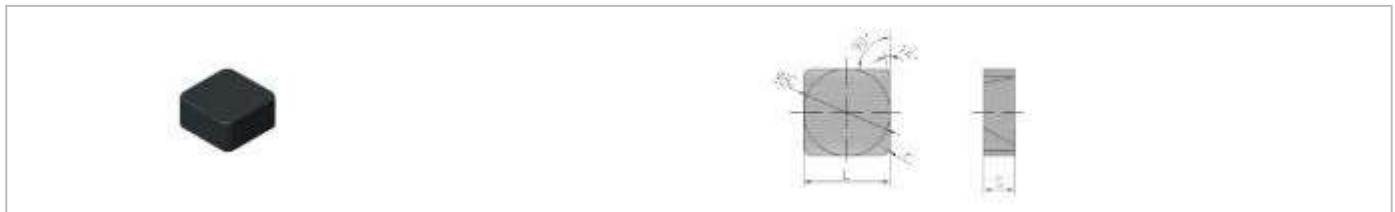

Type	Dimensions				PCBN						
ISO	L	ϕ i.c	s	r	A3N50	A7N00	A7N50	A7N60	A9N00	A9N50	A9N60
SNEN19T6ENS	19.05	19.05	6.8	1.6	●	●	●		●	●	
SNEN1207XGR	12.7	12.7	7.94	1.2	●	●	●		●	●	

● Indicate Priority Selection

Super Soldering Inserts

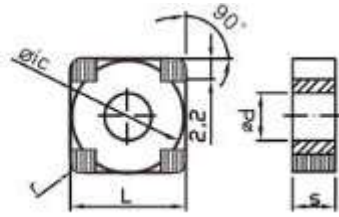

Type	Dimensions					PCBN	
	L	ϕ i.c	s	r	ϕ d	A7S50	A9N60
SNGA120404 S01020-8S	12.7	12.7	4.76	0.4	5.16		
SNGA120408 S01020-8S	12.7	12.7	4.76	0.8	5.16	●	●
SNGA120412 S01020-8S	12.7	12.7	4.76	1.2	5.16		

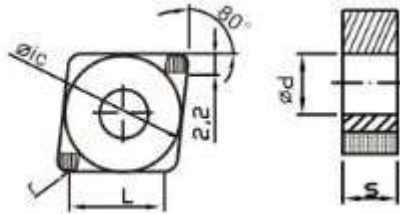

Type	Dimensions					PCBN	
	L	ϕ i.c	s	r	ϕ d	A7S50	A9N60
CNGA120404 S01020-4S	12.9	12.7	4.76	0.4	5.16		
CNGA120408 S01020-4S	12.9	12.7	4.76	0.8	5.16	●	●
CNGA120412 S01020-4S	12.9	12.7	4.76	1.2	5.16		

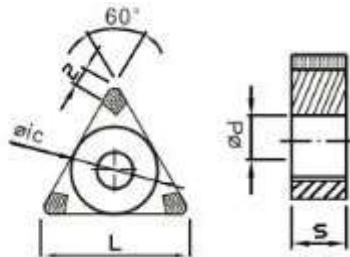

Type	Dimensions					PCBN	
	L	ϕ i.c	s	r	ϕ d	A7S50	A9N60
TNGA110304 S01020-6S	11	6.35	3.18	0.4	2.26		
TNGA110308 S01020-6S	11	6.35	3.18	0.8	2.26	●	●
TNGA110312 S01020-6S	11	6.35	3.18	1.2	2.26		

● Indicate Priority Selection



Type	Dimensions					PCBN	
	L	ϕ i.c	s	r	ϕ d	A7S50	A9N60
TNGA160404 S01020-6S	16.5	9.525	4.76	0.4	3.81		
TNGA160408 S01020-6S	16.5	9.525	4.76	0.8	3.81	●	●
TNGA160412 S01020-6S	16.5	9.525	4.76	1.2	3.81		



Type	Dimensions					PCBN	
	L	ϕ i.c	s	r	ϕ d	A7S50	A9N60
TNGA220404 S01020-6S	22	12.7	4.76	0.4	5.16		
TNGA220408 S01020-6S	22	12.7	4.76	0.8	5.16	●	●
TNGA220408 S01020-6S	22	12.7	4.76	1.2	5.16		

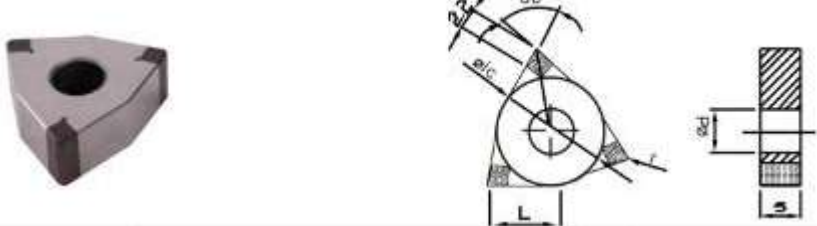

Type	Dimensions					PCBN	
	L	ϕ i.c	s	r	ϕ d	A7S50	A9N60
WNGA080404 S01020-6S	8.7	12.7	4.76	0.4	5.16		
WNGA080408 S01020-6S	8.7	12.7	4.76	0.8	5.16	●	●
WNGA080412 S01020-6S	8.7	12.7	4.76	1.2	5.16		

● Indicate Priority Selection

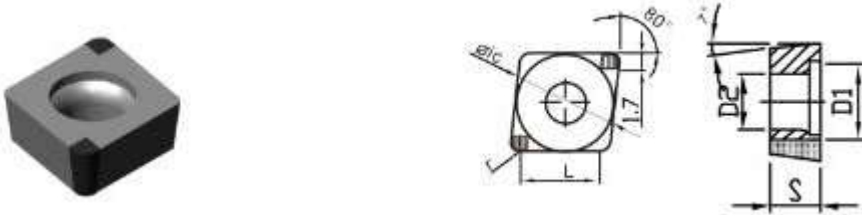

Type	Dimensions						PCBN	
	L	ϕ i.c	s	r	D1	D2	A7S50	A9N60
CCGW09T304 S01020-2S	9.67	9.525	3.97	0.4	4.4	6		
CCGW09T308 S01020-2S	9.67	9.525	3.97	0.8	4.4	6	●	●
CCGW09T312 S01020-2S	9.67	9.525	3.97	1.2	4.4	6		

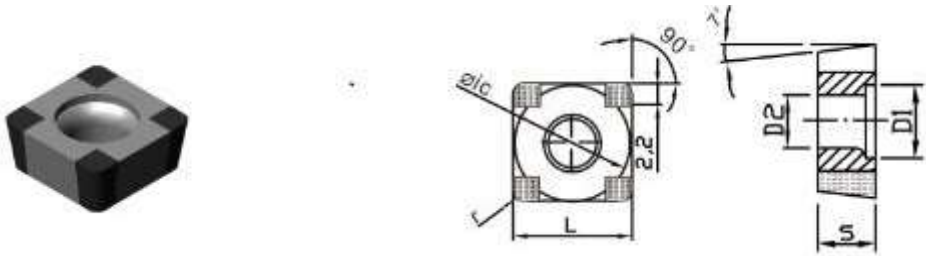

Type	Dimensions						PCBN	
	L	ϕ i.c	s	r	D1	D2	A7S50	A9N60
SCGW09T304 S01020-4S	9.67	9.525	3.97	0.4	4.4	6		
SCGW09T308 S01020-4S	9.67	9.525	3.97	0.8	4.4	6	●	●
SCGW09T312 S01020-4S	9.67	9.525	3.97	1.2	4.4	6		

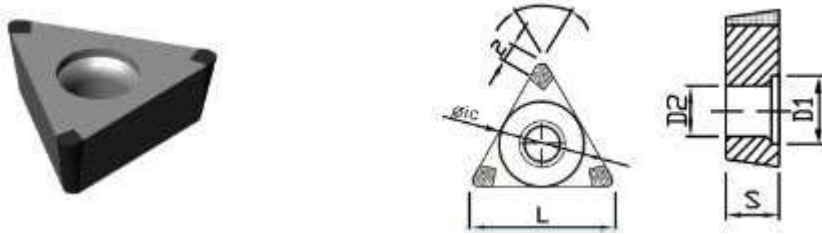

Type	Dimensions						PCBN	
	L	ϕ i.c	s	r	D1	D2	A7S50	A9N60
TCGW09T304 S01020-3S	9.67	9.525	3.97	0.4	2.5	6		
TCGW09T308 S01020-3S	9.67	9.525	3.97	0.8	2.5	6	●	●
TCGW09T312 S01020-2S	9.67	9.525	3.97	1.2	2.5	6		

● Indicate Priority Selection